

TG basic 1

Appliance tester for testing
protective measures
in accordance with DIN VDE 0701-0702
(DIN EN 62638)

Operating manual
(Version 1.00.15 or higher)



Table of contents	Page
1. Safety information	3
2. Introduction	4
3. Safety instructions	5
4. Appropriate usage	6
5. Operating elements	7
6. Starting up	8
6.1. Initial equipping or battery replacement	8
6.2. Switching the tester on and off	
Selecting the measuring sequences, options	8
7. Explanation of terminology	13
7.1. Protection class I (PC I)	13
7.2. Protection class II (PC II)	13
7.3. Protection class III (PC III)	13
7.4. Protective conductor resistance (R_{PE})	13
7.5. Insulation resistance (R_{ISO})	13
7.6. Substitute leakage current (I_{EA})	14
7.7. Visual inspection	14
8. Conducting tests in accordance with DIN VDE 0701-0702; Definition of standards	15
8.1. Visual inspection	15
8.2. Measuring the protective conductor resistance	15
8.3. Measuring the insulation resistance	15
8.4. Measuring the substitute leakage current for devices of protection class I	16
8.5. Measuring the substitute leakage current for devices of protection class II	17
8.6. Inspecting the inscriptions	17
9. Test procedures	18
9.1. Testing devices of protection class I	18
9.1.1. Measuring the protective conductor resistance	18
9.1.2. Measuring the insulation resistance	20
9.1.3. Measuring the substitute leakage current	21
9.1.4. Test assessment	21
9.2. Testing devices of protection class II	22
9.2.1. Measuring the insulation resistance	22
9.2.2. Measuring the substitute leakage current	22
9.2.3. Test assessment	23
9.3. Cable test	23
9.3.1. Protective conductor resistance	24
9.3.2. Insulation resistance	24
9.3.3. Cable test	24
9.4. Measuring the voltage at an external earthed mains socket	26
10. Checking the battery voltage	27
11. Technical data	27
12. Notes on cleaning	28
13. Calibrating the tester	28
14. Manufacturer's guarantee conditions	30

1. Safety information

Tests on the electrical safety of electrical appliances may only be carried out by qualified electricians or under their supervision. Carefully read through the following safety information before starting up the TG Basic appliance tester.

Symbols used in the operating manual and on the appliance tester:



Warning of a hazardous situation. Follow the operating manual.



Caution! Dangerous voltage, danger of electric shock.



Note: Please be sure to follow the manual!



mark of conformity



The operating manual contains information and notes which are necessary for the safe operation and use of the appliance tester. Before using (starting up) the appliance tester, the operating manual should be carefully read through and followed in all points.



If the manual is not observed or if you fail to observe the warnings and notes, serious injury to the user and damage to the appliance tester can occur.



All the technical data and quoted standards in this manual are up-to-date at the time of going to press and have been determined to the best of our knowledge, nevertheless this data may be subject to errors and printing errors. Therefore no legal responsibility or any other liability can be accepted for incorrect information or the consequences of this information.

The respective provisions, regulations and standards are the authorities defining the procedures to be followed when conducting tests.

There is no intention to infringe on any existing patents and other property rights with this publication.

2. Introduction

You have acquired a high-grade device from the company Gilgen, Müller & Weigert with which you can carry out repeatable measurements over a very long period of time.

The product was calibrated during the manufacturing process in accordance with the specified operating procedures.

The TG basic 1 appliance tester, hereafter referred to as the tester, has been developed for carrying out the following measurements for testing the safety of electrical appliances in accordance with DIN VDE 0701-0702 (BGV A3):

- Measuring the protective conductor resistance
- Measuring the insulation resistance
- Measuring the substitute leakage current
- Testing of IEC and extension cables
- Measuring the power socket voltage

Scope of delivery

- 1 qty TG basic 1 appliance tester
- 1 qty set of measuring accessories with safety test line, safety crocodile clip and safety test tip
- 6 qty batteries of type AA (Mignon)
- 1 qty IEC connection cable, 0.5 m
- 1 qty carrying bag
- 1 qty operating manual

Transport and storage

Please retain the original packaging for dispatch at a later date, e.g. for calibration.

Transport damage that occurs due to inadequate packaging is not covered by the manufacturer's guarantee.

The appliance tester must be stored in a dry, closed room. If the device is transported in extreme temperatures, it requires at least 2 hours acclimatisation before being switched on.

3. Safety instructions

The appliance tester was constructed and tested in accordance with the applicable safety regulations and left the factory in a faultless safety condition. In order to maintain this condition and ensure safe operation, the user must observe the instructions and warnings contained in this operating manual.

 With all work, the applicable accident prevention regulations of the trade associations for electrical systems and equipment must be observed.

 To avoid electric shock, the applicable safety regulations and DIN-VDE regulations regarding high touch voltage must be observed without fail when working with voltages greater than 120 V DC or 50 V AC.

Measuring at a dangerous proximity to electrical systems should only be carried out under the instruction of a responsible electrician, and never alone.

Check the appliance tester and the connecting cables for external damage before every new operation.

Make sure that the appliance tester and the cable connections are in faultless condition.

The appliance tester may not be used if one or more functions fail or if functional readiness is not evident.

 The measuring lines and the measuring accessories may only be touched in the designated handling areas. Touching measuring connections, e.g. test tips, must be avoided under all circumstances.

 If the safety of the operator is no longer guaranteed the appliance tester must be decommissioned and secured against unwanted use. This is the case if the device:

- Shows obvious signs of damage
- No longer carries out the required measurements
- Has been stored under adverse conditions for too long

4. Appropriate usage

The tester may only be used under the conditions and for the purposes for which it has been designed. It is particularly important to observe the safety instructions and the technical data regarding ambient conditions and usage in a dry environment.

The appliance tester may not be used for measuring in electrical systems.

Operational safety is no longer guaranteed in the case of modifications or conversions that have not been carried out by the manufacturer.

Maintenance or calibration work may only be carried out by the manufacturer.

Subject the appliance tester to an electromagnetic field can impair the function of the appliance tester.

In order to avoid damaging the appliance tester, the test socket and the test line may not be connected to an external voltage source.

Only the supplied original measuring lines or equivalent safety measuring accessories may be used!

5. Operating elements

Explanation of the appliance tester's connections, operating elements and displays.

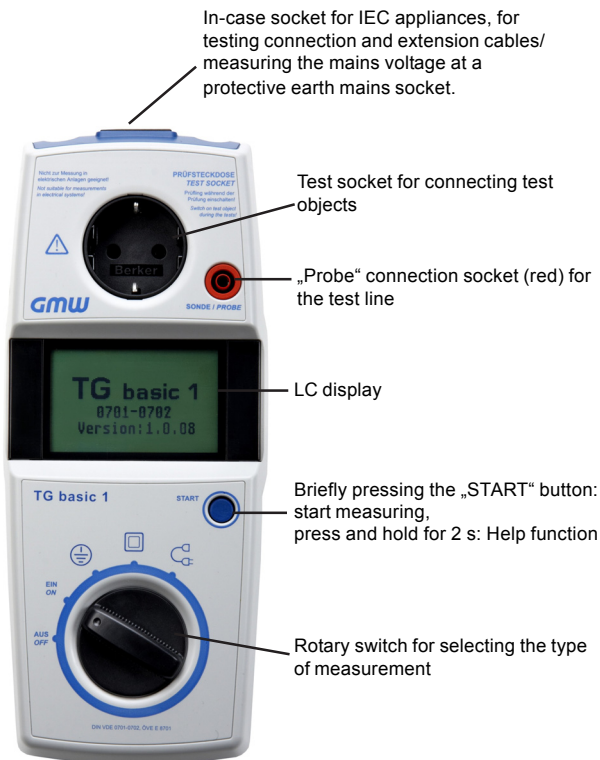

6. Starting up

6.1. Initial equipping or battery replacement

The tester is operated using 6 x 1.5 V type AA batteries (IEC LR6) or six type AA rechargeable batteries.

The six batteries supplied must be inserted into the tester before starting the device.

Proceed as follows to insert the batteries:

- Switch off the device (rotary switch in the „OFF“ position)
- Remove all lines and cables from the test socket, the panel plug for low power devices and the socket for the probe.
- Release the screw from the battery cover
- Lift the cover from the lower part of the case
- Remove the old batteries if necessary
- Insert the batteries into the correct locations in the battery compartment (taking care to ensure correct polarity)
- Click the battery cover into place in the lower part of the case and secure it by tightening the screw

6.2. Switching the tester on and off – Selecting the measuring sequences

The tester is operated via a rotary switch and a „Start“ button.

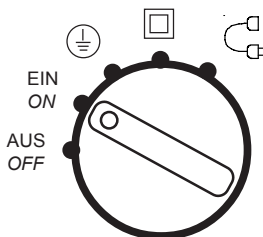

Measurements for devices with protective conductor (PC I)



Measurements for devices without protective conductor (PC II)



Measurements for testing the device connection and extension cable (LPR)

„OFF“ switch position:

Turning the rotary switch to the „OFF“ position switches off the device.

Turn the rotary switch to the „ON“ position to switch on the tester. The device performs a self-test. If the device is OK, the following switch-on message appears in the display:



TG basic 1
0701-0702
Version: 1.0.15



Note that no other functions are available until the switch-on message is displayed!

Selecting the menu language, setting the backlight and selecting the limit values for the R_{PE} measurements

To select the required option, set the rotary switch to the „ON“ position and activate the ‘Start’ button.

Devices with the ‘Backlight’ option show the following menu. Options:

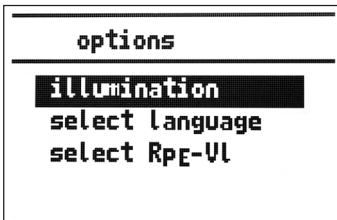

```
options
illumination
select language
select RPE-VL
```

Devices without the backlight option show the following menu:

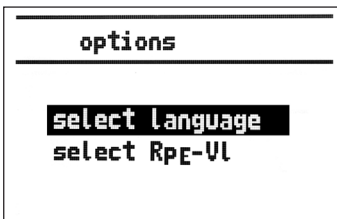

```
options

select language
select RPE-VL
```

Select the required menu item (shown inversely) by pressing the „Start“ button (< 2 s). By pressing the ‘Start’ button (> 2 s), the item is confirmed. The corresponding submenu will be displayed.

Adjusting the backlight intensity

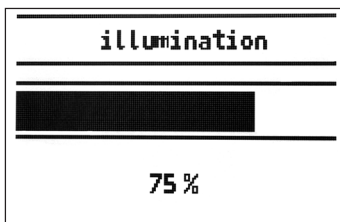

Backlight intensity can be set from 0...100% in steps of 25% by briefly pressing the „Start“ button (< 2 s). Set and save the selected value by pressing the ‘Start’ button for longer (> 2 s).

Language selection

Select the required language (shown inversely) by pressing the „Start“ button (< 2 s). Pressing the „Start“ button for longer (> 2s) confirms the currently selected language and exits the language selection.



R_{PE} selection

Since the limit value for the protective conductor resistance measurement depends on the length of the protective conductor of the test object among other factors, the menu allows the limit value to be set according to the length (see also Section 8.2.) Since the measurement of the protective conductor R_{PE} can be performed in the Protection class I switch position and also in the Cable test switch position, the menu allows definition of which limit values are valid for each type of measurement.

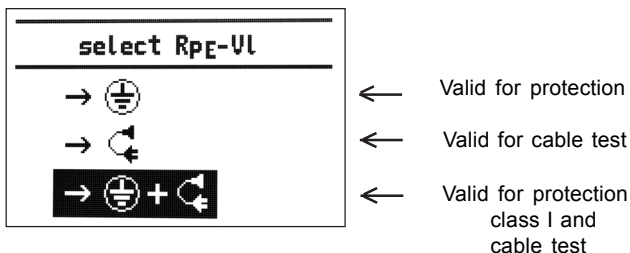

After selecting the validity by briefly pressing the „Start“ button (< 2 s), the desired selection is confirmed by pressing the „Start“ button for a longer time (> 2 s), after which you then reach the following menu:

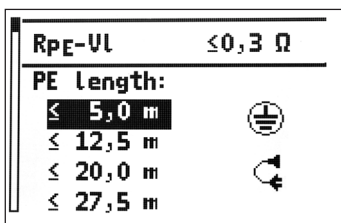

Here, you select the length of the protective conductor of the test object („Start“ button < 2 s). The limit value resulting from this selection is displayed in the upper status bar. The selected limit value is then confirmed by pressing the „Start“ button for a longer time (> 2 s).

The maximum limit value that can be set is ≤ 1 Ohm. The limit value is not permanently stored. This means that the limit value is reset to ≤ 0.3 Ohm when the device is manually switched off via the rotary switch or when the device automatically switches off after approx. 3 minutes.

After the switch-on message has been displayed, the desired operating mode PC I, PC II or cable test can be selected. The „Measuring sequence“ window is displayed depending on the setting of the rotary switch.



Briefly pressing the „START“ button starts the selected measuring sequence.

Pressing the „START“ button for a longer time ($> 2 s$) calls up a quick guide for the select measurement type. Briefly pressing the „START“ button pages forwards through this quick guide.

The scrollbar at the left provides an indication of how many pages are available in the quick guide.

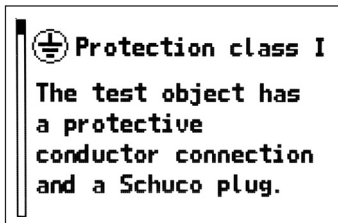

Help window (example)

Pressing the „START“ button for a longer period of time returns you to the „Measuring sequence“ window.

If a measuring sequence is not started within a period of 3 minutes then the tester automatically switches off.

To switch the tester on again, the rotary switch must first be set to the „OFF“ position and then back to the „ON“ position (normal switch-on procedure).

7. Explanation of terminology

7.1. Protection class I (PC I)

The active parts of the device are protected against direct touching by the basic insulation.

Through connection of the touchable conductive housing parts to the protective conductor, these are included in the protective measure in the case of direct touching (fault protection) with the system.

The device has a protective conductor connection (earthed plug).

7.2. Protection class II (PC II)

The active parts are separated by strengthened or double insulation (basic insulation and additional insulation). This ensures protection against direct contact.

Protection against indirect contact also exists, since an insulation fault is practically impossible. Such devices can nevertheless have touchable metallic housing parts. Devices of protection class II have a mains plug without an earth contact.

7.3. Protection class III (PC III)

Devices of protection class III are exclusively connected to protective extra-low voltage electric circuits.

The protection against dangerous body currents is achieved by the low voltage and the safe separation from other electric circuits.

7.4. Protective conductor resistance (R_{PE})

Resistance between any conductive touchable parts, connected to the protective conductor for protective purposes, and the earthed contact of the mains plug, the device plug or the protective conductor, which is constantly connected to the mains power supply.

🔑 See also the measuring principle circuit under point 8.2.

7.5. Insulation resistance (R_{ISO})

This is the Ohmic resistance between conductive parts separated by insulation.

Measurements are taken between the active parts and the body as well as touchable conductive parts that are not connected to the protective conductor.

🔑 See also the measuring principle circuit under point 8.3.

7.6. Substitute leakage current (I_{EA})

Current that would flow through the interconnected active conductors of the device (test object) and the protective conductor or the touchable conductive parts at rated voltage and rated frequency of the device.

This measuring method determines the leakage current without mains voltage.

It is an alternative measuring method for determining protective conductor current or touch current.

🔑 See also the measuring principle circuit under point 8.4.

7.7. Visual inspection

Testing in accordance with DIN VDE 0701-0702 requires a visual inspection of the device. According to the standard, the devices should be inspected for external defects (without opening the device) and, as far as possible, for suitability to the place of installation.

(More details are provided in the DIN VDE 0701-0702 standard).

8. Conducting tests in accordance with DIN VDE 0701-0702 Definition of standards

The sequence of tests is specified in the standard.

8.1. Visual inspection

The test objects are inspected for externally visible defects.

8.2. Measuring the protective conductor resistance (for devices of protection class I)

The limit value is:

$\leq 0.2 \Omega$ for devices with connecting cables up to 5 m, plus 0.1Ω for every extra 7.5 m, up to a maximum of 1.0Ω

Measuring principle circuit
Protective conductor resistance PC I

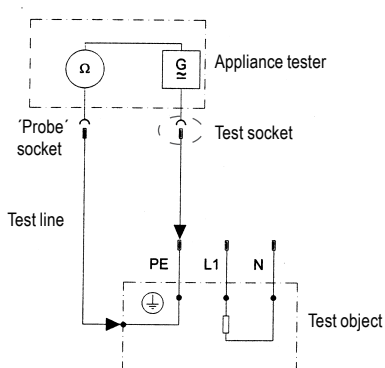

8.3 Measuring the insulation resistance

The limit value is:

1 M Ω for devices of protection class I

2 M Ω for devices of protection class II ¹⁾

0.3 M Ω for devices of protection class I (with switched-on heating elements) ²⁾

¹⁾ Also applies to touchable conductive parts of test objects in protection class I that are not connected to the protective conductor.

²⁾ If the required insulation resistance is not achieved in the case of test objects in protection class I with heating elements with a total capacity ≥ 3.5 kW, the test object is nevertheless rated as faultless if the protective conductor current does not exceed the limit values.

Measuring principle circuit
Insulation resistance PC I

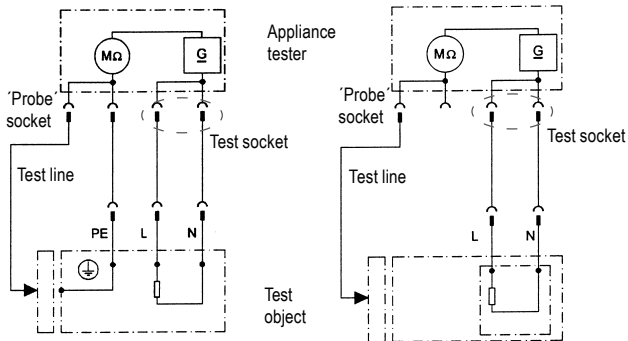

8.4. Measuring the substitute leakage current for devices of protection class I

The substitute leakage current procedure is an alternative method for measuring the protective conductor current.

The limit value is 3.5 mA.

The substitute leakage current for test objects with heating elements having a total connected power greater than 3.5 kW must not be greater than 1 mA/kW heating power, up to a maximum value of 10 mA.

Measuring principle circuits
Substitute leakage current procedure PC I

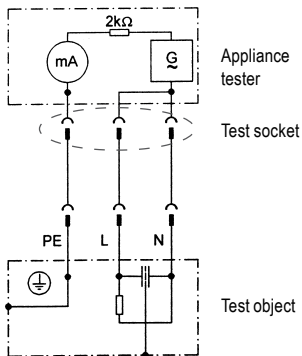

8.5. Measuring the substitute leakage current for devices of protection class II

The substitute leakage current procedure is an alternative method for measuring the touch current.

The limit value is 0.25 mA.

Measuring principle circuits
Substitute leakage current procedure PC II

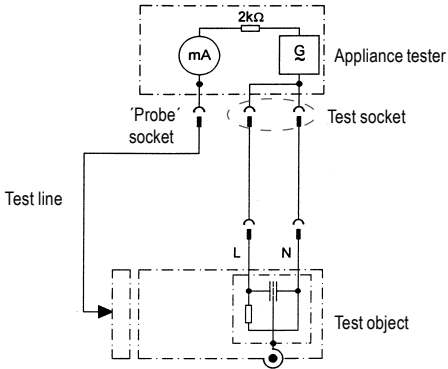

8.6. Inspecting the inscriptions

Safety-related inscriptions must be controlled and, where necessary, renewed or supplemented in suitable form.

9. Test procedures

9.1. Testing devices of protection class I

Rotary switch position: 

Test object connection:



The test procedure occurs automatically in the sequence specified below:

- Protective conductor resistance
- Insulation resistance
- Substitute leakage current

 Please note: The test object must be switched on. The test sequence is started by pressing the „Start“ button for < 2 s.

9.1.1. Measuring the protective conductor resistance

The protective conductor resistance is measured using a measuring current > 200 mA DC. The direction of current is automatically reversed by the tester.

The measuring sequence is indicated on the display as follows:

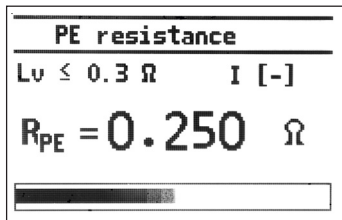

Exceeding of the limit value is indicated as follows:

- The momentary measurement value blinks
- An audio signal is emitted

At the start of measuring, the tester checks to see if the measuring current is greater than 200 mA. If this is not the case, the test is aborted.

This can occur for the following reasons:

- The test object is not of protection class I
- The test object is not connected to the tester or the test line is not connected
- The protective conductor has an open-circuit

This is indicated by a scrolling message in the status line.

The tester performs the following checks:

a) Check of the test wiring!

The measurement procedure is continued when the missing connection to the test line or test object is restored and the measuring current is > 200 mA.

b) Check that the appliance conforms to protection class I!

If the tester detects that the appliance does not conform to protection class I, then the test must be aborted by pressing the „START“ button.

If the test wiring is „OK“ and the test object conforms to protection class I, then the protective conductor connection has an open-circuit or high resistance. The test must be aborted by pressing the „START“ button.

When the test is aborted, the assessment window is shown in the display.

Measurement of the insulation resistance and substitute leakage current is not performed.

This also applies when the measured protective conductor resistance is $> 1 \Omega$.

X	$R_{PE} = 1.100 \Omega$
R_{ISO}	----- $M\Omega$
I_{EA}	----- mA
	Test FAIL! 

When performing the protective conductor resistance measurement, the automatic test sequence can also be switched to a permanent measurement (max. 3 min).

When the tester is in the normal measuring mode, pressing the „START“ button switches the tester into the permanent measurement mode.

The bar graph is then no longer shown in the display.

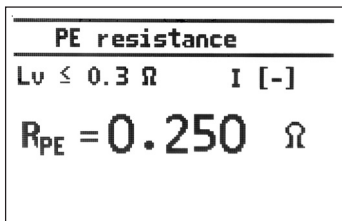

Pressing the button again continues the measurement with a reversed test current polarity. Pressing the button again ends the protective current measurement and continues with the next measurement in the measuring sequence.

During permanent measurement, the connecting cable of the test object should be moved, section by section, along its whole length, in order to find broken conductors or weak points. The momentary measurement values are continuously acquired and displayed by the tester. The maximum measurement value is stored and displayed in the assessment window at the end of the measuring sequence.

9.1.2. Measuring the insulation resistance

The insulation resistance is measured automatically. Switching to permanent measurement is not possible.

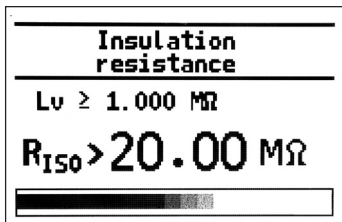

Failure to reach the limit value is indicated as follows:

- The momentary measurement value blinks
- An audio signal is emitted

9.1.3. Measuring the substitute leakage current

The substitute leakage current is measured automatically. Switching to permanent measurement is not possible.

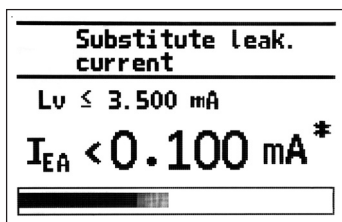

Exceeding of the limit value is indicated as follows:

- The momentary measurement value blinks
- An audio signal is emitted

9.1.4. Test assessment

When the automatic test sequence finishes, an assessment window is displayed.

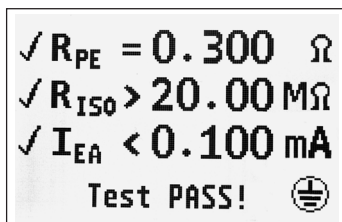

The measurements and their assessments („X“ or „✓“) are displayed here.

The status bar displays „Test PASS“ or „Test FAIL“ depending on the result.

Briefly pressing the „START“ button will repeat the test or perform a new test if a new test object has been connected. Pressing the „START“ button for longer than 2 s will display the quick guide (see point 6.2.)

9.2. Testing devices of protection class II

- Testing devices without a protective conductor and with touchable conductive parts
- Testing devices with a protective conductor and with touchable conductive parts that are not connected to the protective conductor

Caution:

- ☞ With these appliances, this test can only check the insulation resistance and the substitute leakage current between the touchable electrical components that are not connected to the protective conductor and the L and N connections.

Testing of the protective conductor resistance and the substitute leakage current relating to the protective conductor must first be performed after the measuring sequence for protection class I appliances.

Rotary switch position:

Test object connection:



The test procedure occurs automatically in the sequence specified below:

- Insulation resistance
- Substitute leakage current

- ☞ The test object must be switched on (mains switch). The test sequence is started by pressing the „Start“ button for 2 s.

9.2.1. Measuring the insulation resistance

The same statements apply as in point 9.1.2.

9.2.2. Measuring the substitute leakage current

The same statements apply as in point 9.1.3.

9.2.3. Test assessment

The measurements and their assessments („X“ or „✓“) are displayed here.

The status bar displays „Test PASS“ or „Test FAIL“ depending on the result.

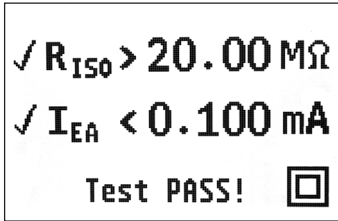

Briefly pressing the „START“ button will repeat the test or perform a new test if a new test object has been connected.

Pressing the „START“ button for longer than 2 s will display the quick guide.

9.3. Cable test

The cable test allows testing of IEC cables (appliance connection cables with non-heating device connections), distribution boxes and extension cables.

Rotary switch position:



The test procedure occurs automatically in the sequence specified below:

- Measuring the protective conductor resistance
- Measuring the insulation resistance
- Cable test

9.3.1. Protective conductor resistance

The same statements apply as in point 9.1.1.

9.3.2. Insulation resistance

The same statements apply as in point 9.1.2.

9.3.3. Cable test

This test provides an additional function that is not part of the DIN VDE 0701-0702 standard.

This test checks a connection cable or extension cable for open-circuits in the live (L) and neutral (N) conductors and for short-circuits between L and N.

Cable test assessment window:

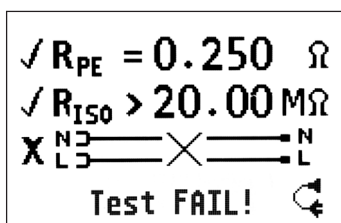

Line open-circuit

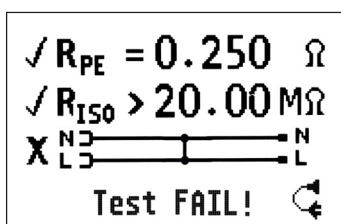

Line short-circuit

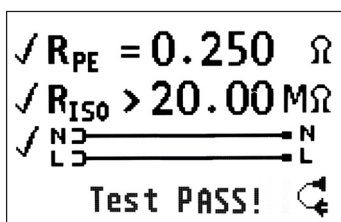

Line OK

- 🔑 only by version:
- Great Britain
 - Switzerland;
 - Czech
 - France
 - Poland

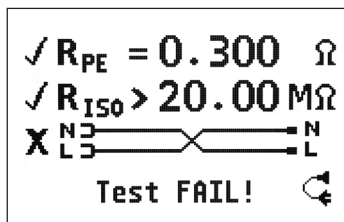

L & N swapped

Briefly pressing the „START“ button will repeat the test or perform a new test if a new test object has been connected. Pressing the „START“ button for longer than 2 s will display the quick guide.

9.4. Measuring the voltage at an external earthed mains socket

The test allows checking of the voltage potentials between the L-N, L-PE and N-PE terminals. The L-PE and N-PE display depends on the position of the live conductor in the earthed mains socket (right or left).

To perform the measurement, plug the IEC line provided with the tester into the IEC socket of the tester.

The rotary switch must be in one of the following positions.

The measuring process starts automatically if voltage is present at the socket.



The measuring process starts automatically if voltage is present at the socket.

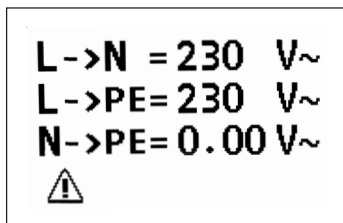

- ☞ Only the voltage potentials between the connection terminals are measured. The measurement provides no information as to whether the earthed mains socket has been correctly installed.
- ☞ No warning message is provided if a dangerous touch voltage exists on the PE conductor.

10. Checking the battery voltage

Before each measurement, the tester automatically checks that the charge level of the batteries is sufficient for correct execution of the respective measurement.

If this is not the case, the following information is displayed:

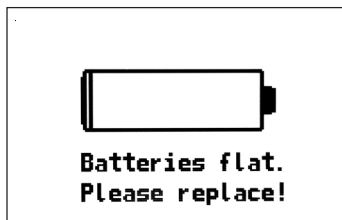

In this case the tester must be switched off and the batteries replaced as described in point 6.1.

11. Technische Daten

Protective conductor resistance:

Measuring range:	0.1...2.000 Ω
Display range:	0.05...2 Ω
Resolution:	0.001 Ω
Tolerance:	\pm (5% + 2 digits)
Measuring current/voltage:	min. \pm 200 mA DC / > 4 V

Insulation resistance:

Measuring range:	0.1...20 M Ω
Display range:	0.1...20 M Ω
Resolution:	
im Bereich 0.1...9.999 M Ω	\geq 0.001 M Ω
im Bereich 10.00...20.00 M Ω	\geq 0.01 M Ω
Tolerance:	\pm (5% + 2 Digit)
Measuring voltage/current:	min. 500 V DC / >1 mA

Substitute leakage current:

Measuring range:	0.1...20 mA
Display range:	0.1...20 mA
Resolution:	
Range 0.1...9.999 mA	\geq 0.001 mA
Range 10.0 ...20.00 mA	\geq 0.01 mA
Tolerance:	\pm (5% + 2 Digit)
Measurement voltage:	approx. 32 V AC

Measuring the voltage at an external earthed mains socket

Measuring range:	50...270 V AC
Display range:	50...270 V AC
Resolution:	1 V
Tolerance:	± 5 %

General technical data:

Power supply:	6 x 1.5 V batteries Typ IEC LR6 (AA) 6 x 1.2 V NiMH rechargeable batteries
Degree of pollution:	2
Overvoltage category:	CAT II 300 V
Protection degree:	IP40
Protection class:	II
Electrical safety:	EN61010-1/VDE0411
EMC emission:	EN61000-6-3
EMC interference resistance:	EN61326-1
Dimensions (L x W x H):	Approx. 265 x 110 x 50 mm
Weight:	Approx. 700 g

Note: The device was developed, built and inspected in accordance with DIN VDE 0404 Parts 1, 2 and DIN VDE 0413, Parts 1, 2, 4

12. Notes on cleaning

When dirty, the tester is to be cleaned with a dry cloth (no solvents) or an anti-static cloth.

The tester must be protected from shock and impacts.

13. Calibrating the tester

According to the DIN VDE 0701-0702:2008-06 standards:

„Measuring devices used for testing must be regularly checked and calibrated.“

We recommend a calibration interval of one year. Shorter periods are recommended if the tester is frequently used or used under tough conditions. If the tester is seldom used then the calibration interval can be extended up to a maximum of 3 years.

14. Manufacturer's guarantee conditions

The TG basic 1 appliance tester is subject to a strict quality inspection. Nevertheless, we grant a 24-month manufacturer's guarantee in the case of malfunctions during normal daily usage. Manufacturing or material faults will be remedied, free of charge, as long as the tester shows no signs of third party actions and is unopened before it is sent back to us.

Damage resulting from the device being dropped or mishandled is excluded from guarantee claims.



Gilgen, Müller & Weigert (GMW)

GmbH & Co. KG

Am Farrnbach 4A · D-90556 Cadolzburg
Germany

Phone +49(0)9103 7129-0

Telefax +49(0)9103 7129-207/205

E-mail: info@g-mw.de · Internet: www.g-mw.de